

ABC's of Spray Painting
\$10.00 A-2928-A

ABC's of Spray Painting



DEVILBISS®

Forward

While this book examines the spray finishing operation and its equipment from many viewpoints, there is still much more to be learned to become truly proficient at spray finishing.

The best way to become proficient at spray finishing is to just do it! Many trade technical and community colleges offer courses in spray finishing, a great way to improve your skills.

Many of the “tricks” of the professional spray finisher involve paints and coatings. The manufacturers of these materials routinely publish complete books on these subjects. These publications are available in specialty paint stores and will provide you with considerable detail. Many of these books also contain information on techniques for surface preparation.

Another important source of information, particularly on equipment use and selection is your local spray finishing equipment distributor. No book could ever completely cover a specialist’s in-depth knowledge of equipment, techniques, maintenance and troubleshooting.

Information is available from many resources on the subject of spray finishing. It is our hope that this book will provide you with a start toward perfecting your finishing skills.

A recent addition to resources available to the spray finisher is the World Wide Web. Many manufactures are represented and question and answer forums are available. Please visit our websites at www.devilbiss.com and www.binks.com.

About this book.....

This book has been updated several times from “The ABC’s of Spray Equipment,” originally published by The DeVilbiss Company in 1954. It focuses on equipment and techniques for spray finishing.

The format of the original book was question-and-answer. We have retained that format in this edition.

This book is organized around the major components of an air spray system... spray guns, material containers, hose, air control equipment, compressors, spray booths, respirators and a short section on general cleanliness and other sources of information. A thorough understanding of the material in this book - plus a lot of actual spray painting practice - should enable you to handle just about any spray painting situation.

Although we have made an effort to make this book as detailed and as complete as possible, be aware that the equipment and product systems used to illustrate points are entirely based on DeVilbiss technology. DeVilbiss is the world’s oldest and largest manufacturer of spray painting equipment, and has maintained this leadership since its founding in 1888.

Table of Contents

Forward	2
1. Introduction	3
Surface Preparation.....	3
Paint Preparation.....	3
2. Air Atomizing Spray Guns.....	4
Spray Gun Types	4
Part Identification and Function.....	6
Operation	9
Maintenance	11
Troubleshooting	13
3. Material Containers.....	16
4. Hose and Connections ...	18
5. Air Control Equipment.....	20
6. Respirators	22
7. Air Compressors.....	23
8. Spray Booths	25

1. Introduction

This book is about the selection, use and maintenance of finishing equipment: spray guns, tanks, cups, hoses, compressors, regulators, spray booths, respirators, etc. It presumes that you are familiar with standard surface preparation techniques that may be required before finishing actually begins. It also presumes a basic knowledge of the many different types of paints and coatings available.

Creating a perfect finish requires a solid knowledge of surface preparation, finishes and spray painting equipment. The first two are extensively covered in many other books. The manufacturers of paints and coatings have gone to great length to publish information on their new and existing products.

But, even an extensive knowledge of surface preparation techniques and paint chemistry is not enough to assure a professional finish. The finish must be applied by a spray gun, and all the variables of its use must be mastered.

The equipment necessary to apply the finish – the spray gun, tank, cup, regulator, hoses, compressor, etc. – must all be matched to the job as well as to each other. That equipment must be used and maintained properly, with an appreciation of how and why it works the way it does.

The moment of truth for any finish happens when the trigger is pulled. This book focuses on that moment.

Surface Preparation

The surface to be finished should be well cleaned before painting. If the paint manufacturer's instructions call for it, the surface should be chemically treated. Use a blow-off gun and tack rag to remove all dust and dirt. No amount of primer or paint will cover up a badly prepared surface.

Plastic parts may contain static electricity from the molding process. This static attracts particles of dust and dirt. Eliminate them by treating with “destatisizing” air using a special blow-off gun that imparts a neutral charge to the airflow. A chemical anti-static treatment is also available.

Paint Preparation

Today's finishes are extremely complex chemical formulations. They include both solvent and waterborne types. Some may require the addition of solvents to form the proper spraying viscosity. Others may simply require the addition of a second component at a prescribed ratio to obtain sprayable consistency. Many of them also have hardeners or other chemicals, added to them to insure correct color match, gloss, hardness, drying time or other characteristics necessary to produce a first class finish. Make sure you are familiar with the specific finish material data sheets accompanying each material. Do not mix materials from various manufacturers. Read and follow directions carefully.

All finish materials must also be supplied with a Material Safety Data Sheet (MSDS). This data provides information on proper handling and disposal of materials. Many states require that MSDS be kept on file by the user.

The first step is knowing the type and color of paint the project requires. With this determined, follow the manufacturer's instruction for preparing it exactly. If you have any doubts about how to proceed, don't guess! Contact your paint supplier for help. Improperly prepared paint will never produce a good finish!

The chief characteristic that determines the sprayability of paint and how much film may be applied is its viscosity ... or consistency. Following the paint manufacturer's instructions will get

you close, but for professional results, use a viscosity cup. It is a simple but very accurate way to measure the thickness of paint. With the cup, you can thin or reduce the paint to the precise consistency required by the manufacturer.

Always prepare paint in a clean, dust-free environment. Paint has a remarkable ability to pick up dirt. Dirty paint will not only clog your spray gun, but it will also ruin your paint job. Get in the habit of always pouring paint into the cup or tank through a paint strainer. Paint is never as clean as it looks.

2. Air Atomizing Spray Guns

Introduction

The spray gun is the key component in a finishing system. It is a precision engineered and manufactured instrument. Each type and size is specifically designed to perform a certain, defined range of tasks.

As in most other areas of finishing work, having the right tool for the job goes a long way toward getting professional results.

This chapter will help you know which is the proper gun by reviewing the Conventional Air and High Volume/Low Pressure spray gun designs commonly used in finishing - suction feed, gravity feed and pressure feed. It will also review the different types of guns and components within each design.

A thorough understanding of the differences between systems will allow you to select the right gun, to use it properly to produce a high quality finish and to contribute toward a profitable finishing operation.

SPRAY GUN TYPES

1. What is an air spray gun?

An air spray gun is a tool which uses compressed air to atomize paint, or other sprayable material, and to apply it to a surface.

Air and material enter the gun through separate passages and are mixed at the air cap in a controlled pattern.

2. What are the types of air spray guns?

Air spray guns may be classified in various ways. One way is by the location of the material container:

Figure 1 shows a gun with a cup attached below it.

Figure 3 shows a gun with a cup attached above it.

Figure 4 shows a material container some distance away from its pressure feed gun.

The type of material feed system is also a way of classifying guns:

Suction Feed... draws material to the gun by suction as in Figure 1.

Gravity Feed... the material travels down, carried by its own weight and gravity as in Figure 3.

Pressure Feed... the material is fed by positive pressure as in Figure 4.

Guns may also be classified as either external or internal mix depending upon the type of air cap.

3. What is a suction feed gun?

A spray gun design in which a stream of compressed air creates a vacuum at the air cap, providing a siphoning action. Atmospheric pressure on the material in the suction cup forces it up the suction tube, into the gun and out the fluid tip, where it is atomized by the air cap. The vent holes in the cup lid must be open. This type gun is usually limited to a one-quart, or smaller, capacity container and low to medium viscosity materials.



Figure 1- Suction Feed Gun with attached cup

Suction feed is easily identified by the fluid tip extending slightly beyond the face of the air cap, see figure 2.

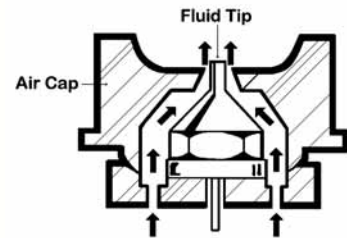

Figure 2 - Suction Feed Air Cap

Suction feed guns are suited to many color changes and to small amounts of material, such as in automotive panel/bumper repairs and "completes," touchup, or lower production operations.

4. What is a gravity feed gun?

This design uses gravity to flow the material from the cup, which is mounted above the gun, into the gun for spraying. No fluid pickup tube is used, since the fluid outlet is at the bottom of the cup.

This cup has a vent hole at the top of the cup that must remain open. It is limited to 34 ounce capacities due to weight and balance.

Gravity feed guns are ideal for small applications such as automotive panel/bumper repairs and "completes," spot repair, or for finishing in a limited space. They require less air than a suction feed gun, and usually have less overspray.

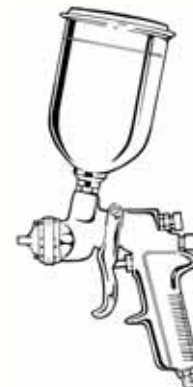

Figure 3- Gravity Feed Gun with attached cup

2. Air Atomizing Spray Guns (Cont'd)

A DeVilbiss Pro Tip:

When using a gravity feed system, downsize the tip one size from suction. If the suction system calls for a .070", use a .055" or .063"

5. What is a pressure feed gun?

In this design, the fluid tip is flush with the face of the air cap (see Figure 5). The material is pressurized in a separate cup, tank or pump. The pressure forces the material through the fluid tip and to the air cap for atomization.

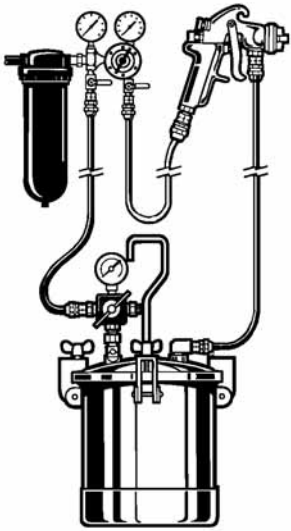

Figure 4 - Typical Pressure Feed Gun with remote pot

This system is normally used when large quantities of material are to be applied, when the material is too heavy to be siphoned from a container or when fast application is required. Production spraying in a manufacturing plant or fleet refinishing operation is a typical use of a pressure feed system

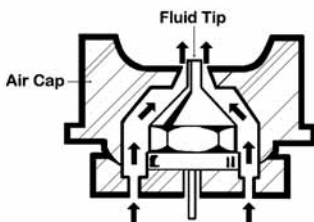

Figure 5 - Pressure Feed Air Cap

Type Feed	Viscosity (#2 Zahn)	Fluid Oz/Minute	Atomizing Pressure	Type Production
Suction	up to 24	10-12	40-50	Low
Gravity	up to 24	10-12	30-50	Low
Pressure	up to 29	12-24	50-60	High

6. What is an external mix air cap?

This gun mixes and atomizes air and fluid outside the air cap.

It can be used for applying all types of materials, and it is particularly desirable when spraying fast drying paints such as basecoat and lacquer. It is also used when a high quality finish is desired.

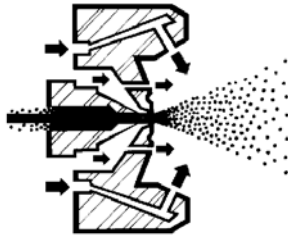

Figure 6 - External Mix Gun

7. What is an internal mix cap?

This cap mixes air and material inside the air cap, before expelling them.

It is normally used where low air pressures and volumes are available, or where slow-drying materials are being sprayed.

A typical example is spraying flat wall paint, or outside house paint, with a small compressor.

Internal mix caps are rarely used for finishing when a fast-drying material is being sprayed, or when a high quality finish is required.

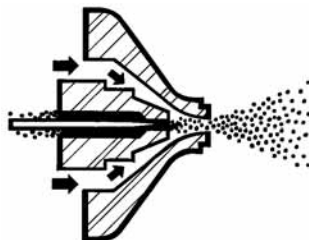

Figure 7 - Internal Mix Air Cap

8. What is HVLP?

HVLP, or High-Volume/Low Pressure, uses a high volume of air (typically between 15-26 CFM) delivered at low pressure (10 PSI or less at the air cap) to atomize paint into a soft, low-velocity pattern of particles.

In many cases, less than 10 psi is needed in order to atomize.

Proper setup utilizes no more fluid and air pressure than is needed to produce the required quality and a flow rate that will meet production requirements.

As a result, far less material is lost in overspray, bounceback and blowback than with conventional air spray. This is why HVLP delivers a dramatically higher transfer efficiency (the amount of paint that adheres to the substrate compared to the amount of paint sprayed) than spray systems using a higher atomizing pressure.

The HVLP spray gun resembles a standard spray gun in shape and operation. Models that use high inlet pressure (35-80 psi) and convert to low pressure internally within the spray gun are called HVLP conversion guns.

Some HVLP models, particularly those using turbines to generate air, bleed air continuously to minimize back- pressure against the air flow of the turbine.

The air cap design is similar to that of a standard spray gun, with a variety of air jets directing the atomizing air into the fluid stream, atomizing it as it leaves the tip.

HVLP is growing in popularity and new environmental regulations are requiring it for many applications.

HVLP can be used with a wide variety of materials, including two-component paints, urethanes, acrylics, epoxies, enamels, lacquers, stains, primers, etc.

2. Air Atomizing Spray Guns (Cont'd)

PART IDENTIFICATION FUNCTION

9. What are the principal parts of a spray gun?

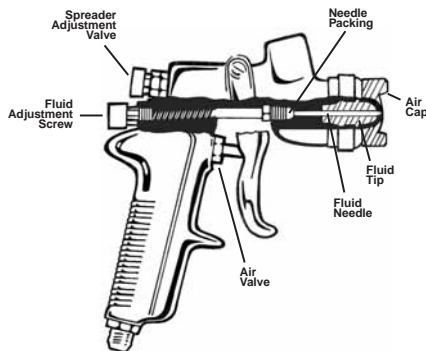

Figure 8 - Spray Gun Anatomy

10. What happens when the trigger is pulled?

The trigger operates in two stages. Initial trigger movement opens the air valve, allowing air to flow through the gun.

Further movement of the trigger pulls the fluid needle from its seat at the fluid tip, allowing fluid material to flow. When the trigger is released, the fluid flow stops before the air flow.

This lead/lag time in the trigger operation assures a full spray pattern when the fluid flow starts. It also assures a full pattern until the fluid flow stops, so there is no coarse atomization.

11. What is the function of the air cap?

The air cap (see figure 10) directs compressed air into the fluid stream to atomize it and form the spray pattern. (see Figure 9)

Round Tapered Blunt

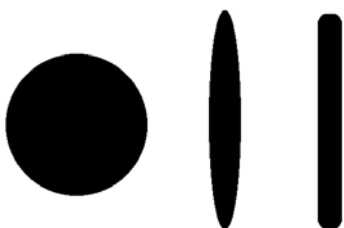

Figure 9 - Types of Spray Patterns

There are various styles of caps to produce different sizes and shapes of patterns for many applications.

12. What are the advantages of the multiple jet cap?

This cap design provides better atomization of more viscous materials.

It allows higher atomization pressures to be used on more viscous materials with less danger of split spray pattern.

It provides greater uniformity in pattern due to better equalization of air volume and pressure from the cap.

It also provides better atomization for materials that can be sprayed with lower pressures.

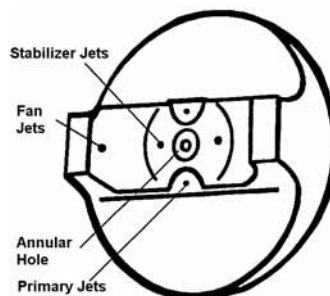

Figure 10 - Multiple Jet External Mix Air Cap

13. How should an air cap be selected?

The following factors must be considered:

- type, viscosity and volume of material to be sprayed
- size and nature of object, or surface to be sprayed (multiple, or larger, orifices increase ability to atomize more material for faster painting of large objects).

Fewer, or smaller orifices usually require less air, produce smaller spray patterns and deliver less material. (These caps are designed for painting smaller objects and/or using slower speeds)

c) material feed system used (pressure, suction or gravity)

d) size of fluid tip to be used (most air caps work best with certain fluid tip/needle combinations)

e) volume of air in cubic feet per minute (cfm) and pressure in pounds per square inch (psi) available.

See the DeVilbiss spray gun catalog for proper selection of air cap / fluid tip / needle combinations and typical uses.

14. What is the function of the fluid tip and needle?

They restrict and direct the flow of material from the gun into the air stream. The fluid tip includes an internal seat for the tapered fluid needle, which reduces the flow of material as it closes. (see Figure 11).

The amount of material that leaves the front of the gun depends upon the viscosity of the material, the material fluid pressure and the size of the fluid tip opening provided when the needle is unseated from the tip.

Fluid tips are available in a variety of sizes to properly handle materials of various types, flow rates and viscosity.

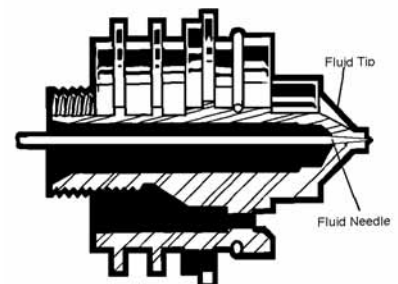

Figure 11 - The Fluid Tip and Needle

2. Air Atomizing Spray Guns (Cont'd)

15. What is the nozzle combination?

In practice, the air cap, fluid tip, needle and baffle are selected as a unit, since they all work together to produce the quality of the spray pattern and finish. These four items, as a unit, are referred to as the nozzle combination.

16. What are standard fluid tip sizes and flow rates?

The standard sizes, corresponding fluid tip opening dimensions and flow rates are:

Plus Technology (High Efficiency)	
Tip Size	Max. Flow Rate
Gravity Feed	
1.2 mm/.047"	6 oz./min.
1.3 mm/.051"	7 oz./min.
1.4 mm/.055"	8 oz./min.
1.5 mm/.059"	9 oz./min.
1.6 mm/.062"	10 oz./min.
1.8 mm/.070"	heavy-bodied material
Suction Feed	
1.6 mm/.062"	9 oz./min.
1.8 mm/.070"	12 oz./min.
Pressure Feed	
1.0 mm/.039"	10 oz./min.
1.4 mm/.055"	16 oz./min.
	or heavy-bodied material

HVLP Technology	
Tip Size	Max. Flow Rate
Gravity Feed	
1.2 mm/.047"	4 oz./min.
1.3 mm/.051"	5 oz./min.
1.4 mm/.055"	6 oz./min.
1.5 mm/.059"	7 oz./min.
1.6 mm/.062"	8 oz./min.
1.8 mm/.070"	heavy-bodied material
Suction Feed	
1.8 mm/.070"	6 oz./min.
2.0 mm/.078"	7 oz./min.
2.2 mm/.086"	8 oz./min.
Pressure Feed	
1.1 mm/.042"	12 oz./min.
1.4 mm/.055"	16 oz./min.
	or heavy-bodied material

Conventional Air Spray	
Tip Size	Max. Flow Rate
Gravity Feed	
1.2 mm/.047"	6 oz./min.
1.3 mm/.051"	7 oz./min.
1.4 mm/.055"	8 oz./min.
1.5 mm/.059"	9 oz./min.
1.6 mm/.062"	10 oz./min.
1.8 mm/.070"	heavy-bodied material
Suction Feed	
1.6 mm/.062"	9 oz./min.
1.8 mm/.070"	12 oz./min.
Pressure Feed	
1.1 mm/.042"	12 oz./min.
1.4 mm/.055"	16 oz./min.
	or heavy-bodied material

Rule of thumb

Optimum fluid pressure is 8-20 psi. Pressures greater than this generally indicate the need for a larger fluid tip size.

17. How are fluid tip and needle sizes identified?

DeVilbiss fluid tips and needles are identified by the letters stamped on the tip and the needle.

The identification letters on these components should match. See the appropriate DeVilbiss spray gun catalog for the proper selection of fluid tip and needle combinations.

18. What fluid tip and needle combination sizes are most common?

1.0, 1.1, 1.4 and 1.8 are most generally used. The 1.4 and 1.6 combination is used for gravity feed, while 1.6 and 1.8 are used for suction feed. For pressure feed the most common tips are 1.1mm and 1.4mm.

19. How are nozzle combinations selected?

Five basic considerations are involved in selecting the nozzle combination:

- type and viscosity of material being sprayed
- physical size of object being finished/fan pattern size
- desired speed/finish quality
- gun model being used
- available air volume (cfm) and pressure (psi) from compressor

(1) The type and viscosity of the material being sprayed is the first factor to consider.

Rule of thumb

The lower the viscosity of the material, the smaller the I.D. of the fluid tip.

Material Viscosity #2 Zahn	Production Rate	Tip Size
up to 23 sec	Low	1.1 mm
23-28 sec	Med	1.4 mm
28-48 sec	High	1.8 mm
over 48 sec	High	2.2 mm

NOTE: Viscosity conversion charts are available to convert one viscosity cup reading to another from any material or equipment supplier.

(2) The physical size of the object to be painted must also be considered. As a general rule, use the largest possible spray pattern consistent with the object size. Remember that different air caps deliver various pattern characteristics. This can reduce both spraying time and the number of gun passes.

(3) The next consideration in evaluating nozzle combinations is the speed with which the finish will be applied and the desired level of quality.

For speed and coverage, choose a nozzle combination which produces a pattern as wide as possible.

When quality is the deciding factor, choose a nozzle combination which produces fine atomization and a smaller pattern size, thereby giving greater application control.

(4) The model of the gun itself will limit the selection of nozzle combination.

For a DeVilbiss suction feed gun, there are several nozzle types available which are suitable for finishing operations. These

2. Air Atomizing Spray Guns (Cont'd)

nozzles have fluid tip openings ranging from .062" to .086", and are designed to handle viscosities up to 28 seconds in a No. 2 Zahn Viscosity Cup.

For a DeVilbiss pressure feed gun, the amount of material discharged depends upon material viscosity, inside diameter of the fluid tip, length and size of hose, and pressure on the material container or pump.

If the fluid tip opening is too small, the paint stream velocity will be too high. If the fluid tip opening is too large, you will lose control over the material discharging from the gun.

For most HVLP guns, the paint flow shouldn't exceed 16 oz. per minute. For higher flow rates, consult the DeVilbiss HVLP Spray Gun catalog.

(5) Available air supply is the last factor to consider.

Pressure feed air caps consume between 7.0 and 25.0 CFM, depending on design. If your air supply is limited, because of an undersize compressor, or many other air tools are in use at once, the gun will be starved for air, producing incomplete atomization and a poor finish.

20. What are the criteria for selecting a pressure feed nozzle?

While the fluid discharge in ounces per minute from a suction feed gun is relatively stable (largely because it is determined by atmospheric pressure), the fluid discharge from a pressure feed gun depends more upon the size of the inside diameter of the fluid tip and the pressure on the paint container or pump. The larger the opening, the more fluid is discharged at a given pressure.

If the fluid tip ID is too small for the amount of material flowing from the gun, the discharge velocity will be too high. The air, coming from the air cap, will not be able to

atomize it properly causing a center-heavy pattern.

If the fluid tip opening is too large, material discharge control will be lost.

The fluid tip/air cap combination must be matched to each other and to the job at hand. Spray gun catalogs include charts to help you match them properly.

21. Of what metals are fluid tips made?

Tips are made of the following metals:

- a) 300-400 grade stainless steel for both non-corrosive and corrosive materials
- b) Carboly inserts for extremely abrasive materials

22. What is viscosity?

The viscosity of a liquid is its body, or thickness, and it is a measure of its internal resistance to flow. Viscosity varies with the type and temperature of the liquid. Any reference to a specific viscosity measurement must be accompanied by a corresponding temperature specification.

The most common measurement used to determine viscosity in finishing is *flow rate* (measured in seconds from a Zahn, Ford, Fisher or other viscosity cup).

Different viscosity cup sizes are available. Each cup has a hole at the bottom, specified to an exact size. Use a viscosity cup that is designed to handle the time range of the materials in use. Viscosity control is an extremely important and effective method to maintain application efficiency and quality consistency. Always measure viscosity after each batch of material is mixed and make sure material temperature is the same, normally 70° to 80° F.

Viscosity recommendations may be given in poise and centipoise (1 poise=100 centipoise).

Viscosity conversion may be accomplished by consulting a viscosity conversion chart.

23. What is the spreader adjustment valve?

A valve for controlling the air to the horn holes which regulate the spray pattern from maximum width down to a narrow or round pattern (see figure 8).

24. What is the fluid needle adjustment?

This adjustment controls the distance the fluid needle is allowed to retract from its seat in the fluid tip, which allows more or less material through the fluid tip (see figure 14).

With pressure feed systems, the fluid delivery rate should be adjusted by varying the fluid pressure at the pressure pot. Use the fluid adjustment knob for minor and/or temporary flow control. This will extend the life of the fluid needle and tip.

25. What are the components of suction and gravity feed systems?

Typical suction and gravity feed systems consist of: a suction feed or gravity feed spray gun with cup, an air compressor (not shown), a combination filter/air regulator and air hoses (see figure 12).

2. Air Atomizing Spray Guns (Cont'd)

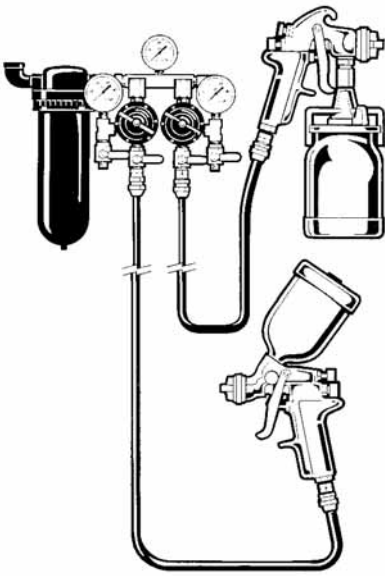

Figure 12 - Suction Feed and Gravity Feed System Components

OPERATION

26. How is suction and gravity feed equipment hooked up for operation?

Connect the air supply from the compressor outlet to the filter/air regulator inlet.

Connect the air supply hose from the air regulator outlet to the air inlet on the spray gun.

After the material has been reduced to proper consistency, thoroughly mixed and strained into the cup, attach the gun to the cup (suction feed) or pour material into attached cup (gravity feed).

27. How are suction and gravity feed systems initially adjusted for spraying?

(1) Spray a horizontal test pattern (air cap horns in a vertical position). Hold the trigger open until the paint begins to run. There should be relatively even distribution of the paint across the full width of the pattern. (see Figure 13). Adjust the pattern width with the spreader adjustment valve. If distribution is not even, there is a problem with either the air cap or the fluid tip

that must be corrected. Refer to the Troubleshooting Section for examples of faulty patterns to help diagnose your problem.

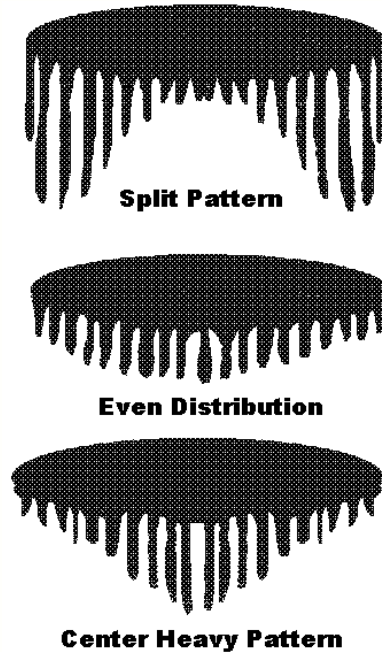

Figure 13 - Horizontal Test Pattern

(2) If the pattern produced by the above test appears normal, rotate the air cap back to a normal spraying position and begin spraying. (Example - a normal pattern with a conventional or #2000 HVLP air cap will be about 10-11" long when the gun is held 8" from the surface).

Fluid Adjustment Screw

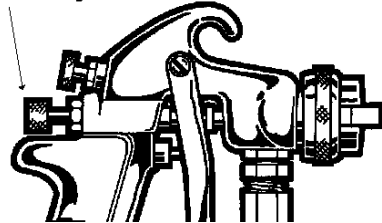
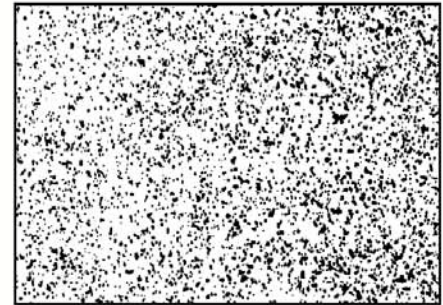

Figure 14 - Fluid Adjustment Screw

(3) With the fluid adjusting screw open to the first thread, (see figure 14) and the air pressure set at approximately 30 psi, or for HVLP 10 psi at the air cap. Make a test pass (move the spray gun 3 times the normal speed) with the gun on some clean paper, cardboard or wood. If there are variations in

particle size- specks and/or large globs - the paint is not atomizing properly (see figure 15).

(4) If the paint is not atomizing properly, increase the air pressure slightly and make another test pass. Continue this sequence until the paint particle size is relatively uniform.



Uneven distribution



Even Distribution

Figure 15- Test Patterns

(5) If the pattern seems starved for material, and the fluid adjustment screw allows full needle travel, the fluid tip may be too small or the material may be too heavy. Recheck the viscosity or increase the size of the fluid tip and needle

(6) If the material is spraying too heavily and sagging, reduce the material flow by turning in the fluid adjusting screw (clockwise).

Remember, proper setup utilizes no more fluid and air pressure than is needed to produce the required quality and a flow rate that will meet production requirements.

2. Air Atomizing Spray Guns (Cont'd)

28. What are the components of a pressure feed system?

A pressure feed system consists of: a pressure feed spray gun, a pressure feed tank, cup or pump, an air filter/regulator, appropriate air and fluid hoses, and an air compressor (see figure 16).

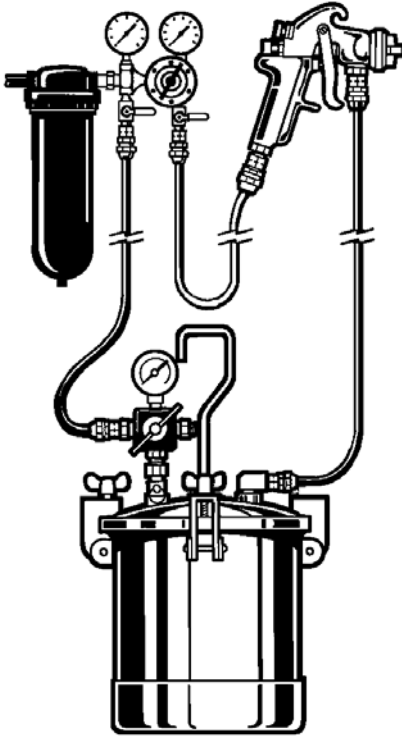

Figure 16 - Pressure Feed System Components

29. How is equipment hooked up for pressure feed spraying?

Connect the air hose from the air regulator to the air inlet on the gun.

Connect the mainline air hose to the air inlet on the tank.

CAUTION: Do not exceed the container's maximum working pressure.

Connect the fluid hose from the fluid outlet on the tank to the fluid inlet on the gun.

30. How is the pressure feed gun adjusted for spraying?

Open spreader adjustment valve for maximum pattern size (see figure 8).

Open fluid adjustment screw until the first thread is visible (see figure 14).

31. How is the pressure feed gun balanced for spraying?

1) Using control knob on fluid regulator, set fluid pressure at 5 to 10 psi.

2) Using control knob on air regulator, set air atomization pressure at 25-50 psi or for HVLP 10 psi at the air cap.

3) Spray a test pattern (fast pass) on a piece of paper, cardboard, or wood. From that test pattern, determine if the particle size is small enough and relatively uniform throughout the pattern to achieve the required finish quality (see figure 15). If particle size is too large or is giving too much texture in the finish, turn the atomization pressure up in 3 to 5 psi increments until particle size and texture of finish is acceptable.

4) Spray a part with these settings. If you are not able to keep up with the production rate required or if the finish is starved for material, increase the fluid pressure with the fluid regulator control knob in 2 to 4 psi increments until required wet coverage is accomplished. Note: A larger capacity fluid tip may be required.

5) Remember, as you turn up the fluid pressure the particle size will increase. Once the coverage required is obtained, it will be necessary to re-adjust the atomization pressure in 3 to 5 psi increments as explained in step 3 to insure required particle size and finish texture is achieved.

6) If using HVLP, using an "Air Cap Test Kit" verify that the air cap pressure is not above 10 psi, if required by a regulatory agency (see figure 17).

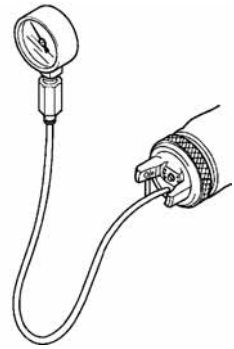

Figure 17 – Air Cap Test Kit

After establishing the operating pressures required for production and finish quality, develop a Pressure Standardization program for your finish room to follow.

32. What is a Pressure Standardization Program?

After establishing air and fluid pressures that meet required quality and production, record the data to be used for that application for future reference. (see figure 18)

Booth #:	_____
Material Sprayed	_____
Application	_____
Viscosity	_____
Fluid Temperature	_____
Spray Gun	_____
Air Cap	_____ Fluid Tip _____
Air Pressure	_____
Fluid Pressure	_____

Figure 18 – Pressure Standardization Chart

33. How should the spray gun be held?

It should be held so the pattern is perpendicular to the surface at all times.

Keep the gun tip 8-10 inches (air spray guns) or 6-8 inches (HVLP guns) from the surface being sprayed.

2. Air Atomizing Spray Guns (Cont'd)

34. What is the proper technique for spray gun stroke and triggering?

The stroke is made with a free arm motion, keeping the gun at a right angle to the surface at all points of the stroke.

Triggering should begin just before the edge of the surface to be sprayed. The trigger should be held fully depressed, and the gun moved in one continuous motion, until the other edge of the object is reached. The trigger is then released, shutting off the fluid flow, but the motion is continued for a few inches until it is reversed for the return stroke.

When the edge of the sprayed object is reached on the return stroke, the trigger is again fully depressed and the motion continued across the object.

Lap each stroke 50% over the preceding one. Less than 50% overlap will result in streaks on the finished surface. Move the gun at a constant speed while the trigger is pulled, since the material flows at a constant rate.

Another technique of triggering is referred to as "feathering." Feathering allows the operator to limit fluid flow by applying only partial trigger travel.

35. What happens when the gun is arced?

Arcing the stroke results in uneven application and excessive overspray at each end of the stroke. When the tip is arced at an angle of 45 degrees from the surface (see figure 19), approximately 65% of the sprayed material is lost.

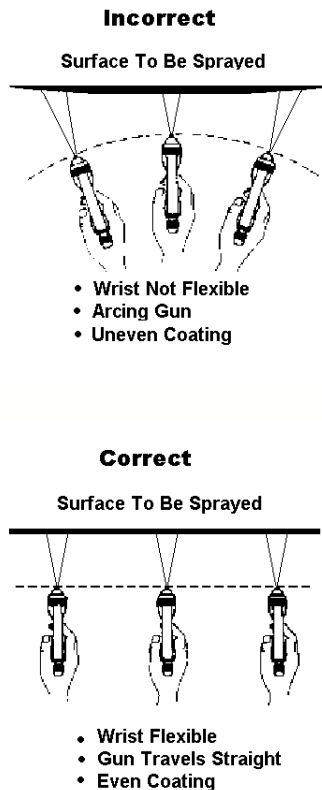

Figure 19 - Spray Techniques

36. What is the proper spraying sequence and technique for finishing applications?

Difficult areas, such as corners and edges, should be sprayed first. Aim directly at the area so that half of the spray covers each side of the edge or corner.

Hold the gun an inch or two closer than normal, or screw the spreader adjustment control in a few turns. Needle travel should be only partial by utilizing the "feathering" technique. Either technique will reduce the pattern size.

If the gun is just held closer, the stroke will have to be faster to compensate for a normal amount of material being applied to smaller areas.

When spraying a curved surface, keep the gun at a right angle to that surface at all times. Follow the curve. While not always physically possible, this is the ideal

technique to produce a better, more uniform, finish.

After the edges, flanges and corners have been sprayed, the flat, or nearly flat, surfaces should be sprayed.

Remember to overlap the previously sprayed areas by 50% to avoid streaking.

When painting very narrow surfaces, you can switch to a smaller gun, or cap with a smaller spray pattern, to avoid readjusting the full size gun. The smaller guns are usually easier to handle in restricted areas.

A full size gun could be used, however, by reducing the air pressure and fluid delivery and triggering properly.

MAINTENANCE

37. How should the air cap be cleaned?

Remove the air cap from the gun and immerse it in clean solvent. If necessary, use a bristle brush to clean dried paint. Blow it dry with compressed air.

If the small holes become clogged, soak the cap in clean solvent. If reaming the holes is necessary, use a toothpick, a broom straw, or the specially designed cleaning needle and handle from a Professional Spray Gun Cleaning Kit.

Cleaning holes with a wire, a nail or a similar hard object could permanently damage the cap by enlarging the jets, resulting in a defective spray pattern.

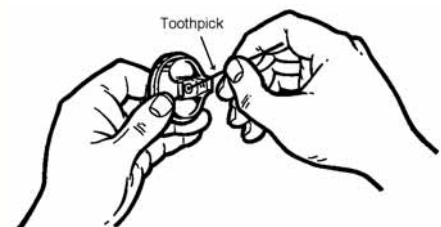

Figure 20 - Cleaning the Air Cap

2. Air Atomizing Spray Guns (Cont'd)

38. How should guns be cleaned?

A suction or pressure feed gun with attached cup should be cleaned as follows:

Turn off the air to the gun, loosen the cup cover and remove the fluid tube from the paint. Holding the tube over the cup, pull the trigger to allow the paint to drain back into the cup.

Empty the cup and wash it with clean solvent and a clean cloth. Fill it halfway with clean solvent and spray it through the gun to flush out the fluid passages by directing stream into an approved, closed container. All containers used to transfer flammable materials should be grounded. (Be sure to comply with local codes regarding solvent disposal).

Then, remove the air cap, clean it as previously explained. Clean outside of fluid tip and baffle area, and replace air cap on the gun.

Wipe off the gun with a solvent soaked rag, or if necessary, brush the air cap and gun with a fiber brush using clean-up liquid or thinner.

To clean a pressure feed gun with remote cup or tank, turn off air supply to cup or tank. Release material pressure from the system by opening relief valve.

Material in hoses may be blown back. The lid must be loose and fluid pressure off. Keep gun higher than container, loosen air cap and trigger gun until atomizing air forces all material back into the pressure vessel.

A gun cleaner may be used for either type of gun. This is an enclosed box-like structure (vented) with an array of cleaning nozzles inside.

Guns and cups are placed over the nozzles, the lid is closed, the valve is energized, and the pneumatically controlled solvent sprays through the nozzles to clean the equipment.

The solvent is contained, and must be disposed of properly.

Some states' codes require the use of a gun cleaner, and it is unlawful to discharge solvent into the atmosphere.

After cleaning a spray gun in a gun cleaner, be sure to lubricate as indicated in Figure 22.

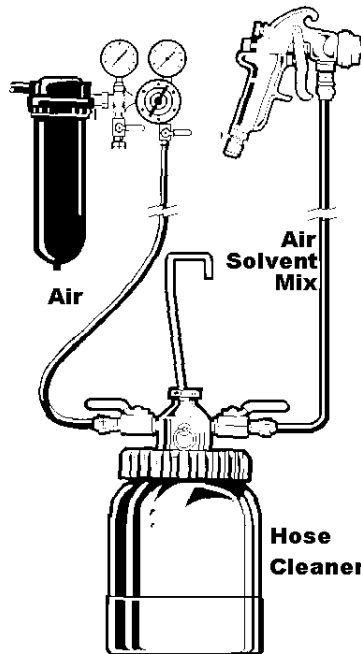

Figure 21 - Using a Hose Cleaner

Use a hose cleaner to clean internal passages of spray guns and fluid hose. This device incorporates a highly efficient fluid header, which meters a precise solvent/air mixture. The cleaner operates with compressed air and sends a finely - atomized blast of solvent through the fluid passages of the hose, the spray gun, etc.

This simple, easy to use cleaner speeds up equipment cleaning and saves solvent. Savings may be as much as 80%. It also reduces VOC emissions. **(Be sure that both the hose cleaner and gun are properly grounded.)**

Where local codes prohibit the use of a hose cleaner, manually backflush the hose into the cup or tank with solvent until clean and dry with compressed air.

Clean the container and add clean solvent. Atomization air should be turned off during this procedure. Pressurize the system and run the solvent through until clean. (Be sure to comply with local codes regarding solvent dispersion and disposal.)

Clean the air cap, fluid tip and tank. Reassemble for future use.

39. What parts of the gun require lubrication? (Figure 22)

The fluid needle packing **A**, the air valve packing **B** and the trigger bearing screw **C** require daily lubrication with a non-silicone/non-petroleum gun lube.

The fluid needle spring **D** should be coated lightly with petroleum jelly or a non-silicone grease (ie. Lithium).

Lubricate each of these points after every cleaning in a gun washer!

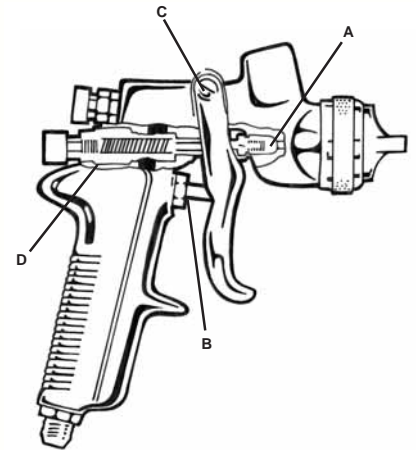

Figure 22 - Lubrication Points

2. Air Atomizing Spray Guns (Cont'd)

Problem

Cause

Correction

Fluid leaking from packing nut

1. Packing nut loose
2. Packing worn or dry

1. Tighten, do not bind needle
2. Replace or lubricate

Air leaking from front of gun

1. Sticking air valve stem
2. Foreign matter on air valve or seat
3. Worn or damaged air valve or seat
4. Broken air valve spring
5. Bent valve stem
6. Air valve gasket damaged or missing

1. Lubricate
2. Clean
3. Replace
4. Replace
5. Replace
6. Replace

Fluid leaking or dripping from front of pressure feed gun

1. Dry packing
2. Packing nut too tight
3. Fluid tip or needle worn or damaged
4. Foreign matter in tip
5. Fluid needle spring broken
6. Wrong size needle or tip

1. Lubricate
2. Adjust
3. Replace tip and needle with lapped set
4. Clean
5. Replace
6. Replace

Jerky, fluttering spray

All Feed Systems

1. Loose or damaged fluid tip/seat
2. Dry packing or loose fluid needle packing nut
3. Material level too low
4. Container tipped too far
5. Obstruction in fluid passage
6. Loose or broken fluid tube or fluid inlet nipple

1. Tighten or replace
2. Lubricate packing or tighten packing nut
3. Refill
4. Hold more upright
5. Backflush with solvent
6. Tighten or replace

Suction Feed Only

7. Material too heavy
8. Air vent clogged
9. Loose, damaged or dirty lid
10. Fluid tube resting on cup bottom
11. Damaged gasket behind fluid tip

7. Thin or reduce
8. Clear vent passage
9. Tighten, replace or clean coupling nut
10. Tighten or shorten
11. Replace gasket

2. Air Atomizing Spray Guns (Cont'd)

Problem

Top or bottom-heavy spray pattern*



Right or left-heavy spray pattern*



Center-heavy spray pattern



Split spray pattern



Cause

1. Horn holes plugged
2. Obstruction on top or bottom of fluid tip
3. Cap and/or tip seat dirty

1. Horn holes plugged
2. Dirt on left or right side of fluid tip

*Remedies for the top, bottom, right, left heavy patterns are:

1. Determine if the obstruction is on the air cap or fluid tip. Do this by making a solid test spray pattern. Then, rotate the cap one-half turn and spray another pattern. If the defect is inverted, obstruction is on the air cap. Clean the air cap as previously instructed.
2. If the defect is not inverted, it is on the fluid tip. Check for a fine burr on the edge of the fluid tip. Remove with #600 wet or dry sand paper.
3. Check for dried paint just inside the opening. Remove paint by washing with solvent.

1. Fluid pressure too high for atomization air (pressure feed)
2. Material flow exceeds air cap's capacity
3. Spreader adjustment valve set too low
4. Atomizing pressure too low
5. Material too thick

1. Fluid adjusting knob turned in too far
2. Atomization air pressure too high
3. Fluid pressure too low (pressure feed)
4. Fluid tip too small

Correction

1. Clean, ream with a toothpick, broom straw or the specially designed cleaning needle and handle from a Professional Spray Gun Cleaning Kit
2. Clean
3. Clean

1. Clean, ream with a toothpick, broom straw or the specially designed cleaning needle and handle from a Professional Spray Gun Cleaning Kit
2. Clean

1. Balance air and fluid pressure
Increase spray pattern width
2. Thin or reduce fluid flow
3. Adjust
4. Increase pressure
5. Thin to proper consistency

1. Back out counter-clockwise to increase flow
2. Reduce at regulator
3. Increase fluid pressure
4. Change to larger tip

2. Air Atomizing Spray Guns (Cont'd)

Problem

Starved spray pattern

Cause

1. Inadequate material flow
2. Low atomization air pressure (suction feed)

Correction

1. Back fluid adjusting screw out to first thread or increase fluid pressure
2. Increase air pressure and rebalance gun

Unable to form round spray pattern

1. Fan adjustment stem not seating properly

1. Clean or replace

Dry spray

1. Air pressure too high
2. Material not properly reduced
3. Gun too far from surface
4. Gun motion too fast

1. Lower air pressure
2. Reduce to proper consistency and select correct temperature solvent
3. Adjust to proper distance
4. Slow down

Excessive overspray

1. Too much atomization air pressure
2. Gun too far from surface
3. Improper technique (arcing, gun speed too fast)

1. Reduce pressure
2. Use proper gun distance
3. Use moderate pace, keeping gun parallel to work surface

Excessive fog

1. Too much, or too fast-drying solvent
2. Too much atomization air pressure

1. Remix with correct temperature solvent
2. Reduce pressure

Will not spray

1. Pressure feed cap/tip used with suction feed
2. No pressure at gun
3. Fluid needle not retracting
4. Fluid too heavy (suction feed)

1. Use suction feed cap/tip
2. Check air lines
3. Open fluid adjusting screw
4. Lower fluid viscosity or change to pressure feed

3. Material Containers

Introduction

All spray painting systems - from the smallest brush to the most sophisticated finishing system - must have containers to hold the material being applied.

Material container types and sizes vary considerably, depending on the kind of spraying system being used.

This chapter will discuss these containers, their particular applications, their construction and maintenance.

1. What are material containers?

Any container which serves as a material supply reservoir for the spray gun. These containers are usually made of metal or plastic with capacities of 1/2 pint or more.

2. What are the types of material containers?

There are three common types of cups which attach to the gun itself: Siphon, Gravity and Pressure.

There are also remote pressure cups and tanks, which are located away from the gun. See Page 4 for types of guns and systems.

3. Where are cup containers used?

Cup containers are typically one quart or less, and are used where relatively small quantities of material are being sprayed.

4. How are material feed cups attached to lid assemblies?

Cups are attached using a lid assembly (sometimes called a cup attachment) that either clamps **A** or screws **B** onto the cup container. (see Figure 1) Some lid assemblies are detachable from the gun, while others are integral

parts and do not detach from less expensive models.

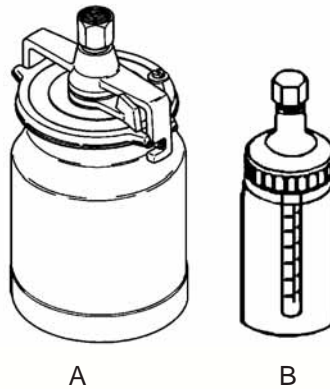

Figure 1 - Cup Attachment Styles

5. What capacity does a pressure feed cup have?

A pressure feed cup can have a one or two quart capacity.

Anything larger is considered a pressure feed tank, which may be positioned some distance from the gun.



Figure 2 - Regulated 2 Qt. Pressure Cup

6. How do pressure feed tanks work?

Pressure feed tanks are closed containers, ranging in size from about two gallons to 60 gallons. They provide a constant flow of material, under constant pressure, to the spray gun.

The tank is pressurized with clean, regulated, compressed air, which forces the fluid out of the tank through the fluid hose to the gun.

The rate of fluid flow is controlled by increasing or decreasing the air pressure in the tank.

A typical pressure feed tank consists of: the shell **A**, clamp-on lid **B**, fluid tube **C**, fluid outlet **D**, regulator **E**, gauge **F**, safety relief valve **G**, and optional agitator **H** (see figure 3).

Pressure feed tanks are available with a top fluid outlet and various accessories.

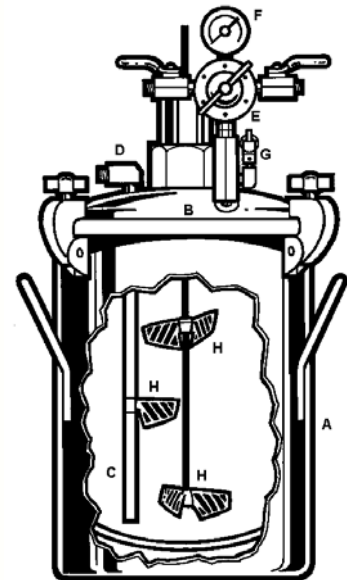

Figure 3 - Pressure Feed Tank

7. Where are pressure feed tanks recommended?

Pressure feed tanks provide a practical, economical method of feeding material to the gun over extended periods of time.

They are mostly used in continuous production situations, because the material flow is positive, uniform and constant.

Tanks can be equipped with agitators (see Figure 3) that keep

3. Material Containers (Cont'd)

the material mixed and in suspension.

8. When is an agitator used in a pressure feed tank?

When the material being used has filler or pigment that must be kept in motion to keep its particles in proper suspension. An agitator can be hand, air or electrically driven.

9. What is a single regulated tank?

This is a pressure feed tank with one air regulator controlling only the pressure on the material in the tank (see figure 4).

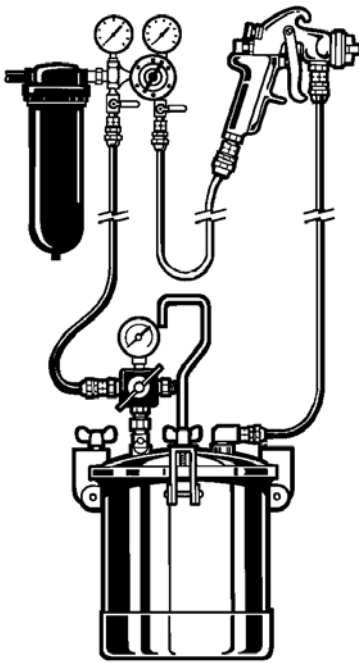

Figure 4 - Single Regulated Tank

10. What is a double regulated tank?

This is a pressure feed tank equipped with two air regulators (see figure 5).

One provides regulation for the air pressure on the material in the tank (thereby controlling fluid flow). The other controls

atomization air pressure to the spray gun.

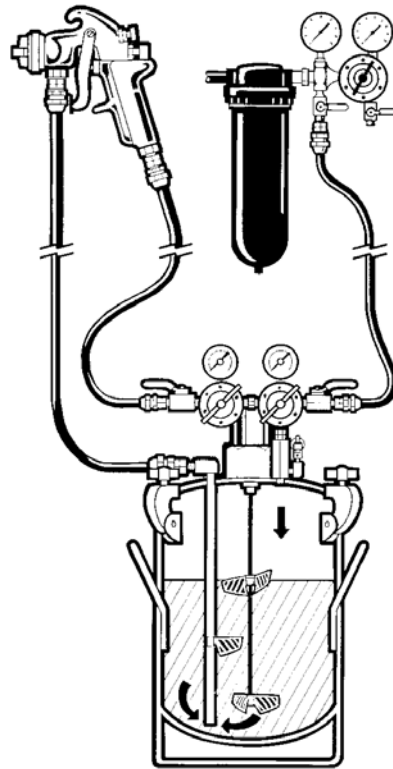

Figure 5 - Double Regulated Tank

11. What are code and non-code pressure tanks?

Code tanks are manufactured to rigid standards as specified by the American Society of Mechanical Engineers. (ASME) Each step of manufacture is closely controlled, and welding of the shell is certified. Code tanks are designed to withstand pressures up to 110 psi.

Non-code tanks are normally restricted to 3 gallons in size or less. Due to the type of construction, non-code tanks are rated at 80 psi or less.

Note:

The A.S.M.E. code, as it relates to pressure vessels attached to spray gun nozzles, is primarily concerned with the use of flammable materials and also covers applications where a tank is used in an OSHA-regulated environment. To comply with OSHA regulations, if you are using a flammable material at greater than 15 PSI and your local fire department has adopted NFPA 33, you must use an A.S.M.E. code tank. Refer to NFPA 33, standard for spray application using flammable or combustible materials.

12. What materials are used to construct pressure feed tanks?

The smaller, non-code, light-duty tanks are made of plated steel and have lower inlet pressure restrictions.

The heavy-duty, ASME-code tanks are made of galvanized or 300 series stainless steel. They also have plated or stainless steel lids with forged steel clamps.

When abrasive or corrosive materials are being sprayed, the tank shell is coated or lined with a special material, or a polyethylene tank liner is used.

13. What are tank liners?

They are inserts that are placed inside the tank to hold the material, keeping it from direct contact with the tank walls. They are made of disposable polyethylene.

Using liners reduces tank cleaning time and makes color changeover and cleanup easier.

4. Hoses & Connections

Introduction

The various types of hose used to carry compressed air and fluid material to the spray gun are important parts of the system. Improperly selected or maintained hose can create a number of problems. This chapter will review the different kinds of hose and fittings in use, provide guidance in selecting the proper types for the job and cover the maintenance of hose.

1. What types of hose are used in spray painting?

There are two types: air hose - used to transfer compressed air from the air source to the gun, and fluid hose - used only in pressure feed systems to transfer the material from its container to the spray gun.

(NOTE: Do *not* use air hose for solvent-based materials.)

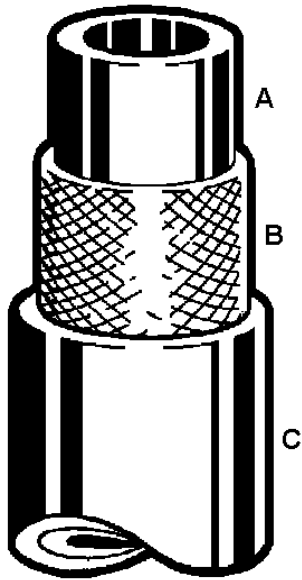

Figure 1 - Basic Hose Construction

2. How is hose constructed?

DeVilbiss hose is a performance designed combination of three components: Tube **A**, Reinforcement **B** and Cover **C**.

The tube is the interior flexible artery that carries air or fluid material from one end of the hose to the other.

The reinforcement adds strength to the hose. It is located between the tube and cover, and it can be many combinations of materials and reinforcement design. Its design determines pressure rating, flexibility, kink and stretch resistance and coupling retention.

The cover is the outer skin of the hose. It protects the reinforcement from contact with oils, moisture, solvents and abrasive objects. The cover protects the reinforcement, but does not contribute to hose performance.

DeVilbiss hose is color-coded:

- RED or TAN air and water
- GREY air w/static ground
- BLACK low pressure fluid

3. What type of tube is used in fluid hose?

Since the solvents in coatings would readily attack and destroy ordinary rubber compounds, fluid hose is lined with special solvent-resistant nylon material that is impervious to common solvents.

4. What sizes of fluid hose are recommended?

Type	Length	Size
General Purpose	0' - 25'	1/4" ID
	25' - 50'	3/8" ID
	50' - 100'	1/2" ID

Figure 2 - Recommended fluid hose sizes

5. What sizes of air hose are recommended?

The hose from the regulator to a gun or tank should be a minimum of 5/16" ID. Tools requiring more air may need 3/8" I.D. hose or larger.

Type	Length	Size
General Purpose	0' - 10'	1/4" ID
	10' - 25'	5/16" ID
	25' - 50'	3/8" ID
HVLP	0' to 25'	5/16" ID
	25' - 50'	3/8" ID
	50' - 100'	1/2" ID

Figure 3 - Recommended air hose sizes

6. What is pressure drop?

This is the loss of air pressure due to friction (caused by air flow) between the source of the air and the point of use. As the air travels through the hose or pipe, it rubs against the walls. It loses energy, pressure and volume as it goes.

7. How can this pressure drop be determined?

At low pressure, with short lengths of hose, pressure drop is not particularly significant. As pressure increases, and hose is lengthened, the pressure rapidly drops and must be adjusted.

All air hose is subject to pressure loss or drop. For example, 1/4" pressure drop is 1 psi per foot and 5/16" is 1/2 psi per foot. This pressure loss may result in poor atomization.

Too often, a tool is blamed for malfunctioning, when the real cause is an inadequate supply of compressed air due to an undersized I.D. hose.

4. Hoses & Connections (Cont'd)

For optimum spray gun results, the following is recommended: up to 25 ft - 5/16" I.D., over 25 ft - 3/8" I.D.

8. How are hoses maintained?

Hoses will last a long time if they are properly maintained.

Be careful when dragging hose across the floor. It should never be pulled around sharp objects, run over by vehicles, kinked or otherwise abused. Hose that ruptures in the middle of a job can ruin or delay the work.

Proper hose cleaning techniques are covered on Pages 11 and 12.

The outside of both air and fluid hose should be occasionally wiped down with solvent. At the end of every job, they should be stored by hanging up in coils.

9. What types of hose fittings are available?

Permanent, crimp type or reusable fittings are used to connect hoses to air sources or to spray equipment.

10. What types of hose connections are available?

Although there are many different styles, the two most common are the threaded and the quick-disconnect types.

Remember that elements added to any hose, such as elbows, connectors, extra lengths of hose, etc., will cause a pressure drop.

On HVLP systems, quick-disconnects must have larger, ported openings (high flow) to deliver proper pressure for atomization. Because of normal pressure drop in these devices, most are not recommended for use with HVLP.

11. What is a threaded-type connection?

This is a common swivel-fitting type that is tightened with a wrench.(see figure 4).

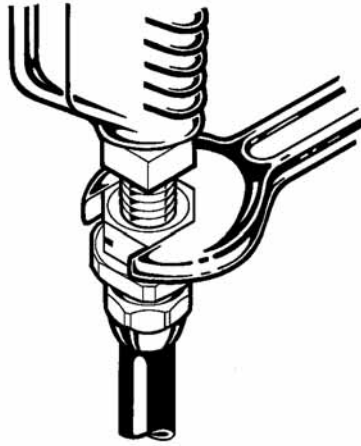

Figure 4 - Threaded-Type Connection

12. What is a quick-disconnect type connection?

This is a spring-loaded, male/female connection system that readily attaches and detaches by hand. No tools are required (see figure 5).

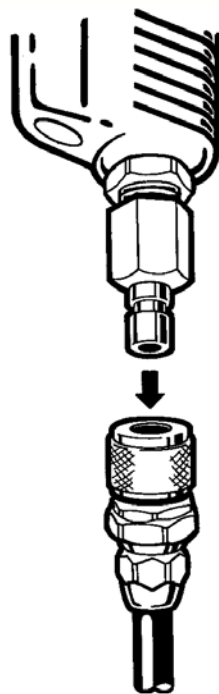

Figure 5 - Quick-Disconnect Type Connection

Care should be taken when selecting a quick-disconnect air connection. Due to design, most Q.D. connections result in significant pressure drop. This can adversely affect spray guns with higher consumption air caps such as HVLP.

5. Air Control Equipment

Introduction

The control of volume, pressure and cleanliness of the air entering a spray gun are of critical importance to the performance of the system.

Following some key installation principles will help decrease the risk of contaminants. For example, it's important to use the right size air compressor for your application. An overworked air compressor can produce a significant amount of dirt and oil. Additionally, proper piping is very important to help prevent condensation from forming within the line and contaminating the air supply.

This chapter examines the various types of equipment available to perform these control functions.

1. What is air control equipment?

Any piece of equipment installed between the air source and the point of use that modifies the nature of the air.

2. Why is air control equipment necessary?

Raw air, piped directly from an air source to a spray gun, is of little use in spray finishing. Raw air contains small, but harmful, quantities of water, oil, dirt and other contaminants that will alter the quality of the sprayed finish. Raw air will likely vary in pressure and volume during the job.

There will probably be a need for multiple compressed air outlets to run various pieces of equipment.

Any device, installed in the air line, which performs one or more of these functions, is considered to be air control equipment.

3. What are the types of air control equipment?

Air control equipment comes in a wide variety of types, but it basically all performs one or more of the following functions; air filtering/cleaning, air pressure regulation/indication and air distribution through multiple outlets.

4. How does an air filter work?

It filters out water, oil, dust and dirt before they get on your paint job. Air entering the filter is swirled to remove moisture that collects in the baffled quiet zone.

Smaller impurities are filtered out by a filter. Accumulated liquid is carried away through either a manual or automatic drain.

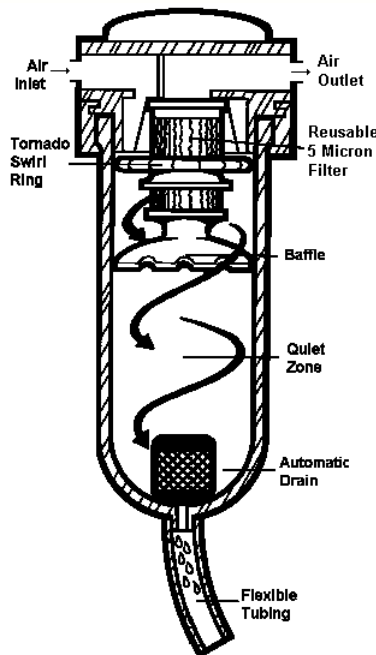

Figure 1 - Air Filter

5. What is an air regulator?

This is a device for reducing the main line air pressure as it comes from the compressor. Once set, it maintains the required air pressure with minimum fluctuations.

Regulators are used in lines already equipped with an air filtration device.

Air regulators are available in a wide range of cfm and psi capacities, with and without pressure gauges and in different degrees of sensitivity and accuracy.

They have main line air inlets and regulated or non-regulated air outlets.

6. How is an air filter/regulator installed?

Bolt the air filter/regulator **A** securely to the spray booth wall near the operator. (see Figure 2)

This location makes it convenient to read the gauges and operate the valves. Install the filter/regulator at least 25 feet from the **B** compressed air source. Install the **C** takeoff elbow on top of the **D** main air supply line.

Piping should slope back toward the compressor, and a **E** drain leg should be installed at the end of each branch, to drain moisture from the main air line.

Use piping of sufficient I.D. for the volume of air being passed, and the length of pipe being used.

Minimum Pipe Size Recommendations*			
Compressor		Main Air Line	
HP	CFM	LENGTH	SIZE
1 1/2 - 2	6-9	Over 50'	3/4"
		Over 200'	1"
3-5	12-20	Up to 200'	3/4"
		Over 200'	1"
		Over 200'	1 1/4"
5-10	20-40	Up to 100'	3/4"
		100' - 200'	1"
		Over 200'	1 1/4"
10-15	40-60	Up to 100'	1"
		100' - 200'	1 1/4"
		Over 200'	1 1/2"

Table 1

5. Air Control Equipment (Cont'd)

*Piping should be as direct as possible. If a large number of fittings are used, larger I.D. pipe should be installed to help overcome excessive pressure drop.

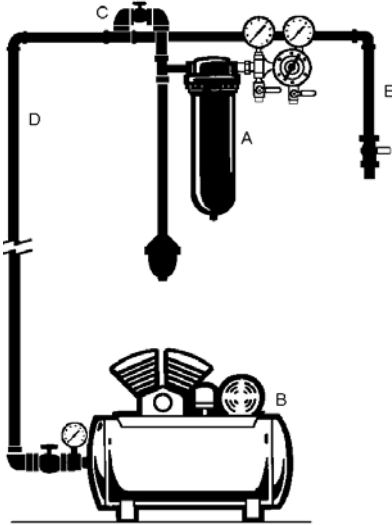

Figure 2 – Air/Filter Regulator Installation

7. How often should the filter/regulator be drained of accumulated moisture and dirt?

It depends largely on the level of system use, the type of filtration in the air system, and the amount of humidity in the air.

For average use, once-a-day drainage is probably sufficient.

For heavily-used systems, or in high humidity, drainage should occur several times daily.

Some units drain automatically when moisture reaches a predetermined level.

8. What steps should be taken if moisture passes through the filter/regulator?

Since moisture in the spray gun atomization air will ruin a paint job, it must be removed from the air supply.

When the compressed air temperature is above its dew point temperature, oil and water vapor will not condense out into solid particles.

Check the following:

- Drain air filter, air compressor tank, and air line of accumulated moisture.
- Be sure the air filter is located at least 25 feet from the air source.
- Main air line should not run adjacent to steam or hot water piping.
- Compressor air intake should not be located near steam outlets or other moisture-producing areas.
- Outlet on the air compressor tank should be near the top of the tank.
- Check for damaged cylinder head or leaking head gasket, if the air compressor is water cooled.
- Intake air should be as cool as possible.

9. What causes excessive pressure drop on the main line gauge of the filter/regulator?

- The compressor is too small to deliver the required air volume and pressure for all tools in use.
- The compressor is not functioning properly.
- There is leakage in the air line or fittings.
- Valves are partially opened.
- The air line, or piping system, is too small for the volume of air required. Refer to Table 1, Page 20.

6. Respirators

Introduction

Consult with appropriate safety personnel or "Industrial Hygienist" if in doubt as to the suitability of a particular respirator before using it. Respirators may not provide protection against eye and skin absorption of chemicals.

Spray finishing creates a certain amount of overspray, hazardous vapors and toxic fumes. This is true, even under ideal conditions.

Anyone near a spray finishing operation should use some type of respirator, or breathing apparatus. This chapter covers various types of equipment for this use.

1. What is a respirator?

A respirator is a mask that is worn over the mouth and nose to prevent the inhalation of overspray fumes and vapor.

2. Why is a respirator necessary?

For two reasons:

First...some type of respiratory protection is required by OSHA/NIOSH regulations.

Second...even if it wasn't a requirement, common sense tells you that inhaling overspray is not healthy.

Overspray contains toxic particles of paint pigments, harmful dust and, in some cases, vapor fumes which can be harmful to your health.

Depending on design, a respirator can remove some, or all, of these dangerous elements from the air around a spray finishing operator.

3. What types of respirators are used by spray finishing operators?

There are three primary types; the air-supplied respirator, the organic vapor respirator and the dust respirator.

4. What is an air-supplied respirator?

This type is available in both mask and visor/hood styles. Both provide the necessary respiratory protection when using materials that are not suitable for organic vapor respirators.

The visor/hood style provides a greater degree of coverage to the head and neck of the operator.

Both styles require a positive supply of clean, breathable air as defined by OSHA (Grade D).



Figure 1 – Positive Pressure Visor/Hood

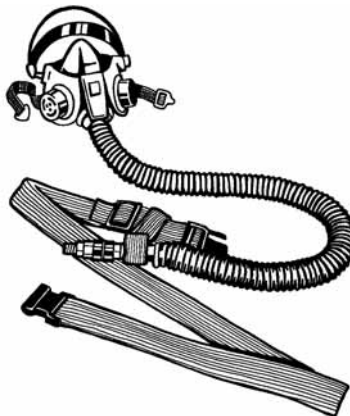

Figure 2 – Positive Pressure Mask Respirator

5. What is an organic vapor respirator and where is it used?

This type of respirator, which covers the nose and mouth, (see Figure 3) is equipped with replaceable cartridges that remove organic vapors by chemical absorption.

Some are designed with pre-filters to remove solid particles from the

air before it passes through the chemical cartridge.

The organic vapor respirator is normally used in finishing operations with standard materials (not suited for paints containing isocyanates).



Figure 3 - Organic Vapor Respirator

6. What is a dust respirator and where is it used?

Dust respirators are sometimes used in spray finishing but, in most applications, they are unsatisfactory. (see Figure 4)



Figure 4 - Dust Respirator

These respirators are equipped with cartridges that remove only solid particles from the air. They have no ability to remove vapors.

They are effective, however, in preliminary operations such as sanding, grinding and buffing.

NOTE:

Before using any respirator, carefully read the manufacturer's Safety Precautions, Warnings and Instructions. Many respirators are not suitable for use with isocyanates, asbestos, ammonia, pesticides, etc.

7. Air Compressors

Introduction

All air tools, spray guns, sanders, etc., must be supplied with air which is elevated to higher pressures and delivered in sufficient volume. The air compressor compresses air for use in this equipment and is a major component of a spray painting system. This chapter will examine the various types available.

Compressed air is measured on the basis of volume supplied per unit of time (cubic feet per minute, or cfm) at a given pressure per square inch (psi), referred to as delivery.

Displacement is the output of air by a compressor at zero pressure, or free air delivery.

1. What is an air compressor?

An air compressor is a machine designed to raise the pressure of air from normal atmospheric pressure to some higher pressure, as measured in pounds per square inch (psi). While normal atmospheric pressure is about 14.7 pounds per square inch, a compressor will typically deliver air at pressures up to 200 psi.

When selecting a compressor:

Rule of thumb

The cubic feet per minute delivered by an electrically powered 2 stage *industrial* air compressor is 4 times the motor's horse power rating. (CFM=4xHP)

2. What types of compressors are most common in spray finishing operations?

There are two common types; the piston-type design and the rotary screw design.

Because most commercial spray finishing operations consume large quantities of compressed air at relatively high pressures, the

piston type compressor is the more commonly used.

3. How does a piston-type compressor work?

This design elevates air pressure through the action of a reciprocating piston. As the piston moves down, air is drawn in through an intake valve. As the piston travels upward, that air is compressed. Then, the now-compressed air is discharged through an exhaust valve into the air tank or regulator.

Piston type compressors are available with single or multiple cylinders in one or two-stage models, depending on the volume and pressure required.

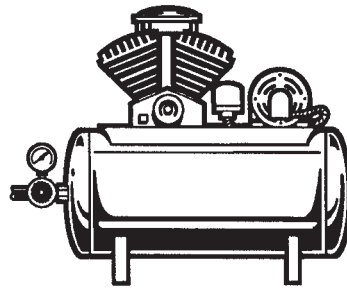

Figure 1 - Piston Type Air Compressor

4. How does a rotary screw compressor work?

Rotary screw compressors utilize two intermeshing helical rotors in a twin bore case. Air is compressed between one convex and one concave rotor. Trapped volume of air is decreased and the pressure is increased.

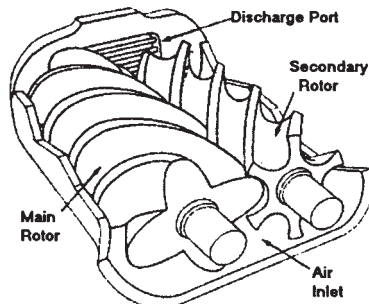

Figure 2 – Rotary Screw Air Compressor

5. What is a single stage compressor?

This is a piston-type compressor with one or more cylinders, in which air is drawn from the atmosphere and compressed to its final pressure with a single stroke.

All pistons are the same size, and they can produce up to 125 psi.

6. Where are single stage compressors used?

The application of this compressor is usually limited to a maximum pressure of 125 psi. It can be used above 125 psi, but above this pressure, two stage compressors are more efficient.

7. What is a two-stage compressor?

A compressor with two or more cylinders of unequal size in which air is compressed in two separate steps.

The first (the largest) cylinder compresses the air to an intermediate pressure. It then exhausts it into a connecting tube called an intercooler.

From there, the intermediate pressurized air enters the smaller cylinder, is compressed even more and is delivered to a storage tank or to the main air line.

Two-stage compressors can deliver air to over 175 psi.

They are normally found in operations requiring compressed air of 125 psi or greater.

8. What are the benefits of two-stage compressors?

Two-stage compressors are usually more efficient. They run cooler and deliver more air for the power consumed, particularly in the over-100 psi pressure range.

7. Air Compressors (cont'd)

9. Is there anything else to know, about air compressors?

Because this book mainly focuses on spray guns, it provides only basic coverage of air compressors and how they operate.

There is much more to know:

How to select the proper equipment in terms of size, delivery, etc.

Compressors may be portable or stationary and there are different models to meet a variety of needs.

8. Spray Booths

Introduction

Containing the overspray and keeping it out of the air and off other objects is an important consideration in a spray finishing operation. This chapter discusses various types of booths and details periodic maintenance.

1. What is a spray booth?

A compartment, room or enclosure of fireproof construction; built to confine and exhaust overspray and fumes from the operator and finishing system.

There are various models available, designed for particular spray applications. Spray booths may be partially enclosed (figures 1 & 2) or totally enclosed (figure 3).

Consult the National Fire Protection Association (NFPA) pamphlet #33 and the O.S.H.A. requirements for construction specifications.

2. What are the benefits of a spray booth?

A well-designed and maintained spray booth provides important advantages:

It separates the spraying operation from other shop activities, making the spraying, as well as the other operations, cleaner and safer.

It reduces fire and health hazards by containing the overspray.

It provides an area that contains residue, making it easier to keep clean. It also keeps both the operator and the object being sprayed cleaner.

In a booth equipped with adequate and approved lighting, it provides better control of the finish quality.

3. What types of spray booths are there?

There are two; the dry filter type and the waterwash type.

4. What is a dry filter type spray booth?

This booth draws overspray-contaminated air through replaceable filters and vents the filtered air to the outside.

It is the most common type of booth for most industrial and automotive applications.

It is used for spraying low-volume, slower-drying materials, and is not affected by color changes.

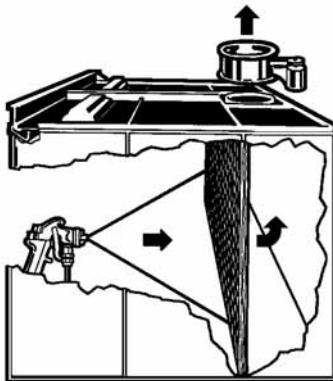

Figure 1 - Dry Filter Type Booth

5. What is a waterwash type booth?

A waterwash booth actually washes the contaminated overspray air with a cascade of water and traps the paint solids. Fewer paint particles reach the outside atmosphere to harm the environment.

Waterwash booths are generally used when spraying high volumes of paint.



Figure 2 - Waterwash Industrial Type Spray Booth

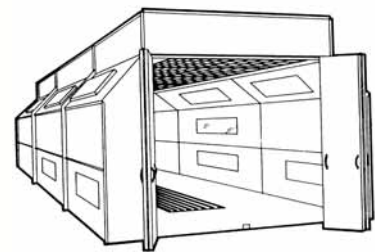

Figure 3 - Automotive Downdraft Dry Filter Booth

6. What is an exhaust fan?

A typical exhaust fan consists of a motor, a multiple blade fan, pulleys and belts. It removes overspray from the spray booth area (see figure 4).

Contemporary exhaust fans are carefully designed to prevent overspray from coming into contact with the drive mechanism.

Blades are made of non-sparking metal, and they move the maximum volume of air-per-horsepower against resistance such as exhaust stacks, filters, etc. (See NFPA pamphlet #33.)

8. Spray Booths (Cont'd)

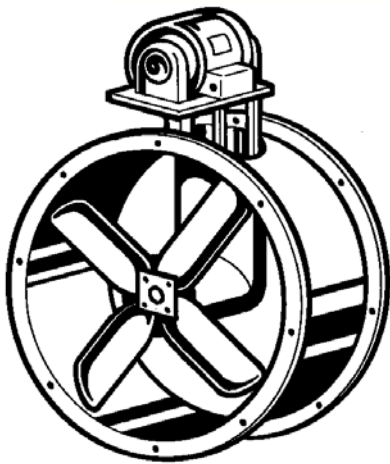

Figure 4 – Exhaust fan

7. What is air velocity?

Air velocity in a finishing operation is the term used to describe the speed of air moving through the empty spray booth.

8. What effect does air velocity have on spray booth efficiency?

Air must move through the booth with sufficient velocity to carry away overspray.

Too low a velocity causes poor, even potentially dangerous working conditions, especially when the material contains toxic elements. It also increases maintenance costs.

Too high a velocity wastes power and the energy required to heat make-up air.

9. What is a manometer?

It is a draft gauge that indicates when paint arrester filters or intake filters are overloaded. (see figure 5)

Some states and local codes require a manometer gauge on each bank of filters to comply with OSHA regulations.

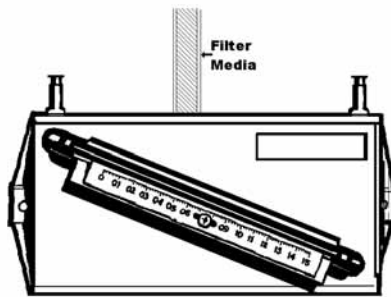

Figure 5 - Manometer

10. What does an air replacement unit do?

The volume of air exhausted from a spray booth is often equal to three or more complete air changes per hour.

Under such conditions, the temperature may become irregular and uncomfortable. Excessive dust may become a problem.

To prevent these conditions, sufficient "make-up" air must be introduced to compensate for the exhausted air.

The air replacement unit automatically supplies this "makeup" air - both filtered and heated - to eliminate the problems of air deficiency and airborne contaminants.

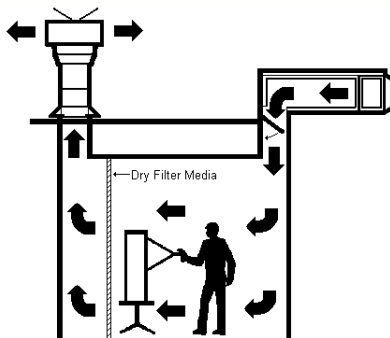

Figure 6 - Air Replacement Unit

11. What routine maintenance does a dry type spray booth require?

(a) The continuous flow of air through the booth eventually loads the filters with dirt and overspray. Periodically, inspect and replace them with multi-

stage filters, designed for spray booth use. Single-stage furnace filters will *not* do the job.

- (b) Monitor the manometer reading daily, and know what a normal reading should be.
- (c) Keep the booth free of dirt and overspray. Floors and walls should be wiped down after every job. Pick up scrap, newspapers, rags, etc.
- (d) Coat the inside of the booth with a strippable, spray-on covering. When the overspray on it becomes too thick, strip and recoat.
- (e) Periodically check the lighting inside the booth, and replace weak or burned out bulbs. Improper lighting can cause the operator to apply a poor finish.

12. What routine maintenance does a waterwash type booth require?

- (a) Compounding of the water in this type unit is essential. Employ only booth treatment chemicals in accordance with suppliers' recommendations. The ph of the water should be between 8 and 9.
- (b) Maintain the water level at the proper setting per manufacturers' specifications.
- (c) Check the tank for paint buildup on the bottom, check the pump strainer to keep it clean and clear, check the air washer chamber and the nozzles in the header pipe. If the nozzles are plugged, the overspray will encroach on the wash baffle section, fan and stack.
- (d) Periodically check the float valve for proper operation. Flood the sheet to be sure there is a uniform flow over the entire surface.

8. Spray Booths (Cont'd)

- (e) Keep the booth interior and exhaust stack free from overspray and dirt accumulation.

13. What checks can be used to assure good results from a spray booth?

- (a) Keep the interior of the booth clean.
- (b) Maintain and replace intake and exhaust filters when necessary.
- (c) Caulk all seams and cracks where dirt might enter.
- (d) Maintain and clean all equipment used in the booth.
- (e) Keep operators' clothing clean and lint-free.
- (f) Perform routine maintenance above on a scheduled basis.

NOTES

NOTES

Sales and Service
Through a Nationwide Network of Distributors



North American Office
World Headquarters
1724 Indian Wood Circle Suite J-K
Maumee, OH 43537
419-891-8100
www.devilbiss.com
www.binks.com
Technical Assistance
800-445-3988 (U.S. and Canada Only)
Fax: 800-445-6643

DEVILBISS®